



P91 Online UPS

5000VA, 6000VA, 10000VA Models

User & Installation Manual

Table of Contents

1 Safety Information.....4

 1.1 Transportation and Storage.....4

 1.2 Preparation.....4

 1.3 Installation.....4

 1.4 Connection.....5

 1.5 Maintenance.....5

 1.6 Recycling the Used Battery.....6

 1.7 Operation.....6

 1.8 Standards.....6

2 Installation7

 2.1 Unpacking and Inspecting.....7

 2.2 Rear Panel View.....8

 2.2.1 XBDM.....9

 2.2.2 Product Overview.....10

 2.2.3 XBDM Installation.....10

 2.2.4 Operation.....11

 2.3 Tower Installation.....12

 2.4 Rack Installation.....12

 2.5 Battery Wiring Diagram.....13

 2.6 Storage and Maintenance.....13

 2.7 UPS Electrical Connections/Installation13

3 Operation.....17

 3.1 User Interface17

 3.1.1 Button Operations.....17

 3.1.2 LED Indicators.....17

 3.1.3 LCD Panel.....18

 3.1.4 Operating Mode/Description.....19

 3.2 UPS Operation.....21

3.3 LCD Settings.....24

4 Troubleshooting.....30

4.1 Audible Alarms.....30

4.2 Warning Indicators.....31

4.3 Warning Code Descriptions31

4.4 Fault Code Descriptions32

4.5 Troubleshooting Chart.....33

5 Specifications.....34

6 Obtaining Service.....35

7 Xtreme Power Conversion Limited Warranty.....36

8 Xtreme Power Conversion Load Protection Policy37

1 Safety Information

Please read carefully the following user manual and the safety instructions before installing the UPS or using the UPS! Please comply with all warnings and operating instructions in this manual. Save this manual and read carefully the following instructions before installing the unit. Do not operate this unit before reading through all safety information and operating instructions carefully.

1.1 Transportation and Storage

- Please transport the UPS system only in the original packaging to protect against shock and impact.
- The UPS must be stored in a room where it is ventilated and dry.

1.2 Preparation

- Condensation may occur if the UPS system is moved directly from cold to warm environments. The UPS system must be absolutely dry before being installed. Please allow at least two hours for the UPS system to acclimate to the environment.
- Do not install the UPS system near water or in moist environments.
- Do not install the UPS system where it would be exposed to direct sunlight or nearby heaters.
- Do not block ventilation holes in the UPS housing.

1.3 Installation

- Do not connect appliances or devices which would overload the UPS (e.g. motor-type equipment) to the UPS output receptacles or terminal.
- Place cables in such a way that no one can step on or trip over them.
- Do not block air vents in the housing of the system components. The UPS system must be installed in a location with good ventilation. Ensure enough space on each side for ventilation.
- UPS has provided a ground terminal for equipotential earth bonding to the external UPS battery cabinets in the final installed system configuration.
- The UPS can be installed only by qualified maintenance personnel.
- An appropriate disconnect device for short-circuit backup protection should be provided in the building wiring installation, upstream of the UPS.
- An integral single emergency switching device which prevents further supply to the load by the UPS in any mode of operation should be provided in the building wiring installation.
- Connect the ground before connecting to the building wiring terminal.
- Installation and wiring must be performed in accordance with the local electrical laws and regulations.

1.4 Connection

- This UPS must be installed and grounded in accordance with local and national electrical code.
- The power supply for this unit must be single-phase rated in accordance with the equipment nameplate. It also must be suitably grounded.



WARNING
HIGH LEAKAGE CURRENT
EARTH CONNECTION ESSENTIAL
BEFORE CONNECTING SUPPLY



CAUTION

Do not dispose of battery or batteries in a fire. The battery may explode.

Do not open or mutilate the batteries. The electrolyte from the batteries is toxic and harmful to the skin and eyes. Risk of Electric Shock –Hazardous voltage may exist between battery terminals and ground. A battery can present a risk of electrical shock and high short circuit current.

1.6 Recycling the Used Battery

- Do not dispose of the battery in a fire. Battery may explode. Proper disposal of battery is required. Refer to your local codes for disposal requirements.
- Do not open or mutilate the battery. Released electrolyte is harmful to the skin and eyes. It may be toxic.
- Do not discard the UPS or the UPS batteries in the trash. This product contains sealed, lead-acid batteries and must be disposed properly. For more information, contact your local recycling/reuse or hazardous waste center.

1.7 Operation

- Do not disconnect the ground conductor cable on the UPS or the building wiring terminals in any time since this would cancel the protective ground of the UPS system and of all connected loads.
- The UPS system features its own, internal current source (batteries). The UPS output receptacles or output terminal blocks may be electrically live even if the UPS system is not connected to the building wiring system.
- In order to fully disconnect the UPS system, first press the “OFF” button and then disconnect the mains.
- Ensure that no liquid or other foreign objects can enter into the UPS system.
- The UPS can be operated by any individuals with no previous experience.

1.8 Standards

* Safety	
Safety Conformance: IEC/EN 62040-1,UL1778 (5th Edition)	
Safety Markings : UL, CE	
* EMI	
Conducted Emission.....:IEC/EN 62040-2,FCC PART15 CLASS A	
Radiated Emission.....:IEC/EN 62040-2,FCC PART15 CLASS A	
*EMS	
ESD.....:IEC/EN 61000-4-2	Level 4
RS..... :IEC/EN 61000-4-3	Level 3
EFT..... :IEC/EN 61000-4-4	Level 4
SURGE..... :IEC/EN 61000-4-5	Level 4
CS..... :IEC/EN 61000-4-6	Level 3
Power-frequency Magnetic field..... :IEC/EN 61000-4-8	Level 4
Low Frequency Signals.....:IEC/EN 61000-2-2	

2 Installation

2.1 Unpacking and Inspection

Unpack the package and check the package contents. The shipping package contains:

- UPS
- User manual
- Front mount brackets and screws
- Viewpower monitoring software CD
- RS-232 cable
- USB cable
- Tower Mounting Feet

Unpack the Battery Pack and check the package contents. The shipping package contains:

- Battery Pack
- User manual
- Front mount brackets and screws
- DC Connection Cable

Unpack the IT60A Isolation Transformer and check the package contents. The shipping package contains:

- Isolation Transformer
- User manual
- Front mount brackets and screws

Unpack the XBDM-P91A or XBDM-P91B and check the package contents. The shipping package contains:

- XBDM
- (2) "L" mounting brackets and screws

NOTE: Before installation, please inspect the system components. Be sure that nothing inside the package was damaged during transportation. Do not turn on the UPS system and notify the carrier and dealer immediately if there is any damage or missing parts. Please keep the original packaging in a safe place for future use.

2.2 Selecting Installation Position

It is necessary to select a proper environment to install the unit, in order to minimize the possibility of damage to the battery pack and extend the life of the batteries. Please follow the instructions below:

- Keep at least 20cm (8 inches) clearance from the rear panel of the unit to the wall or other obstructions.
- Do not block the air-flow to the ventilation openings of the unit.
- Please ensure the installation site environmental conditions are in accordance with the unit's working specifications to avoid overheating and excessive moisture.
- Do not place the unit in a dusty or corrosive environment or near any flammable objects.
- This UPS system is not designed for outdoor use.

2.2 Rear Panel Views

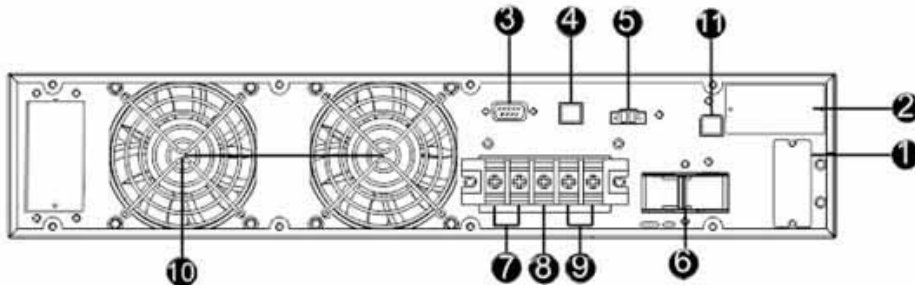

UPS Rear Panel
Figure 2-1

1. External battery connector
2. Intelligent slot
3. RS-232 communication port
4. USB communication port
5. Emergency power off function connector (EPO connector)
6. Input circuit breaker
7. Output terminals
8. Ground
9. Input terminals
10. Cooling Fan
11. External maintenance bypass switch port

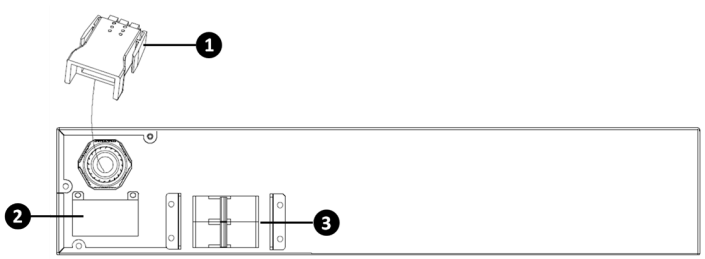

2U battery pack rear view

2U Battery Pack

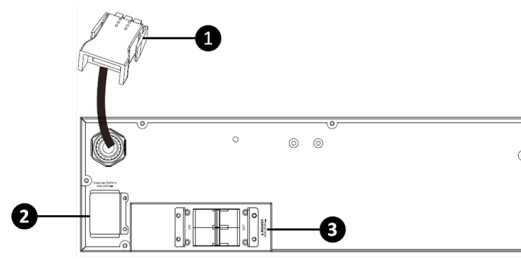

3U battery pack rear view

3U Battery Pack

1. DC connector cable: connects to either UPS or additional battery pack
2. DC connection point for additional battery pack
3. DC breaker: Battery over-current protection breaker

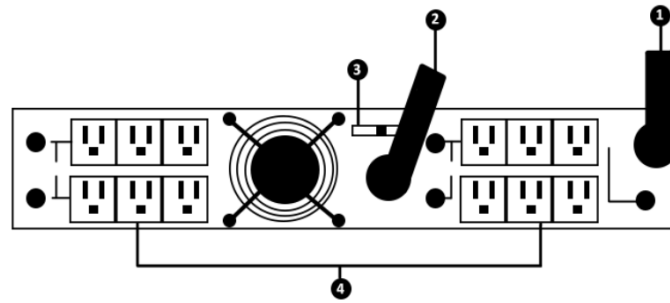
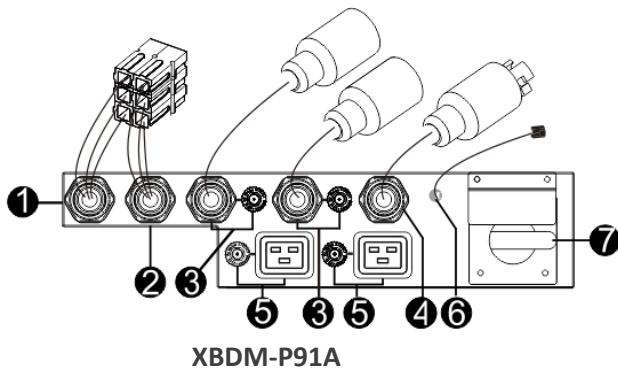

Figure 2-4
IT60A Isolation Transformer Rear Panel

2.2.1 XBDM Introduction

The product is used as an external power distribution unit in conjunction with UPS systems or large-scale voltage regulators. It allows to manually transfer the connected equipment to utility power via a bypass switch, permitting scheduled maintenance or UPS replacement without power interruption. Combined power distribution feature and the master-controlled design, it provides maintenance bypass function and power saving within a rack mechanism.

Product Overview



XBDM-P91A

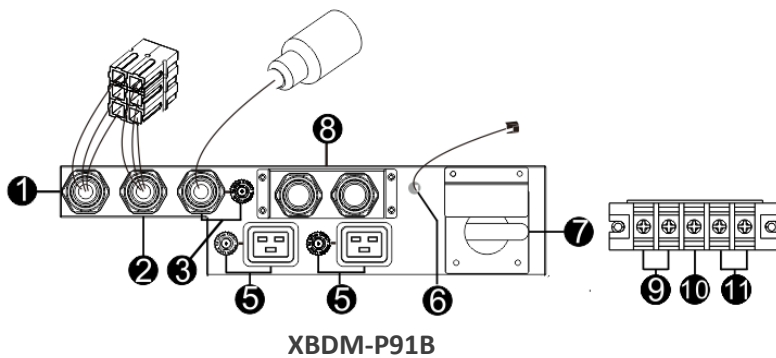

XBDM-P91B

1. Socket to UPS output
2. Socket to UPS input
3. Output cable and Circuit breaker
4. AC input
5. Output receptacle and Circuit breaker
6. RJ45(for connecting ups' EMBS)
7. Bypass switch
8. Terminal Block Cover
9. Output Terminal
10. Earth terminal
11. AC input terminal

2.2.2 Installation of XBDM Unpacking and Inspection

Unpack the package and check the package contents. The shipping package contains:

- Maintenance bypass switch module x 1
- Quick guide x 1
- Mains power cord x 1
- Screws and mounting ears

NOTE: Before installation, please inspect the unit. Be sure that nothing inside the package is damaged during transportation. Do not turn on the unit and notify the carrier and dealer immediately if there is any damage or lacking of some parts. Please keep the original package in a safe place for future use.

Initial Setup

The Installation and wiring must be performed in accordance with the local electric laws/regulations and execute the following instructions by professional personnel.

- 1) Make sure the mains wire and breakers in the building are enough for the rated capacity of UPS to avoid the hazards of electric shock or fire.

NOTE: Do not use the wall receptacle as the input power source for the UPS, as its rated current is less than the UPS's maximum input current. Otherwise, the receptacle may be burned and destroyed.

- 2) Switch off the mains switch in the building before installation.
- 3) Turn off and shut down the connected UPS.
- 4) Prepare wires based on the following table:

NOTE 1: The cable for 10K should be able to withstand over 63A current. It is recommended to use 8AWG or thicker wire for safety and efficiency.

NOTE 2: The selections for color of wires should be followed by the local electrical laws and regulations.

- 5) Remove the terminal block cover on the rear panel of the module. Then connect the wires according to the following terminal block diagrams:

Connect to the AC INPUT AND UPS

Plug the input power cord of the unit to the AC INPUT. Connect a power cord from UPS input to UPS input socket on the unit. Use one power cord to connect UPS output to UPS output socket on the unit.

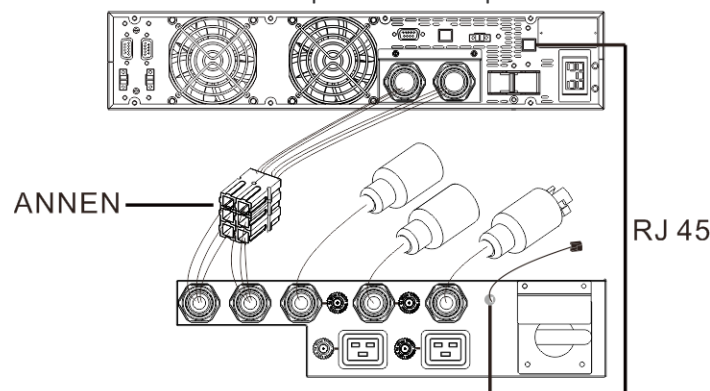

The red connector cord gets installed into the input side of the UPS
 Brown is L1, Blue is L2 (N), Green Yellow is Ground

The black connector cord gets installed into the output side of the UPS

Red is L1, Black is L2 (N), Green Yellow is Ground



**2.2.3 XBDM Operation
 Transfer to Maintenance Bypass**

OUTPUT CORDS
 G, L1, L2(N)

INPUT CORDS
 L1, L2(N), G

To transfer to maintenance bypass from UPS, follow the below steps:

Step 1: Press “OFF” button of UPS unit to transfer to bypass mode.

Step 2: Open the maintenance switch door. If step 1 is not executed first, then UPS unit will transfer to bypass mode automatically with control output signal connection when opening the maintenance switch door.

Step 3: Transfer rotary switch to “BPS” position and switch off UPS input breaker on the module. Then, all devices are directly powered by utility and there is no current through the UPS. The output and input of UPS are isolated from the system. You may now service or maintain the UPS by shutting down the batteries of UPS.

Transfer to UPS Protection

After maintenance service is done, follow below steps to transfer back to UPS operation.

Step 1: Switch on the input breaker of the module and reconnect UPS battery input breaker. Then UPS will enter to bypass mode.

Step 2: Transfer rotary switch to “UPS” position. Then, all devices are powered by utility through UPS bypass mode.

Step 3: Close back maintenance switch door and press “ON” button of UPS unit. Then, all devices are protected by the UPS.

NOTE: If maintenance will be executed in another place, before removing the UPS and the module, please follow steps of “Transfer to Maintenance Bypass” and then disconnect all wires between UPS and the module for complete isolation.

2.2.4 Specification of Critical Components

Parameter		5K/6K Max.	10K Max.
Input breaker	Current	50 A	63 A
	Voltage	250 V	250 V
Bypass switch	Current	80 A	80 A
	Voltage	600 V	600 V

2.3 Tower Installation

The UPS system is shipped with two sets of feet and 6 extensions (2 short extensions plus 4 long extensions) that can be used to tower install the UPS module in battery pack.

Install UPS module

Assemble two feet and one short extension as one tower stand shown in step 1. Align the two stands approximately 14in apart in step 2. Then, put UPS module in the stands as shown in step 3.

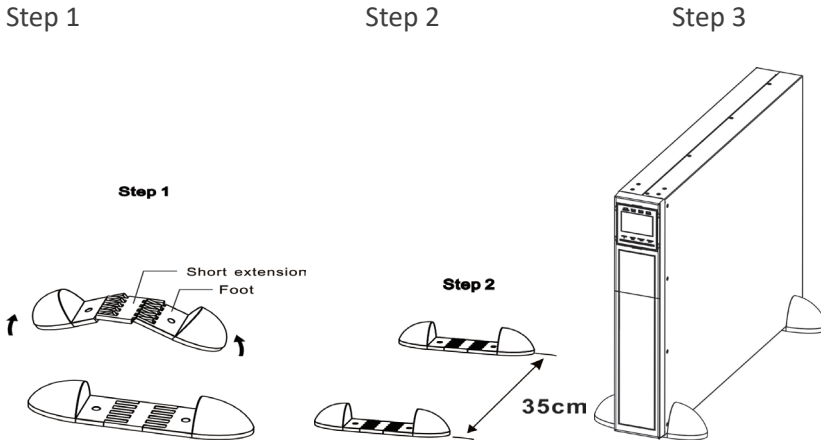

Install UPS module and one battery pack

Assemble two feet and two long extensions as one tower stand shown in step 1. Align the two stands approximately 35cm apart in step 2. Then, put UPS module and battery bank in the stands as shown in step 3.

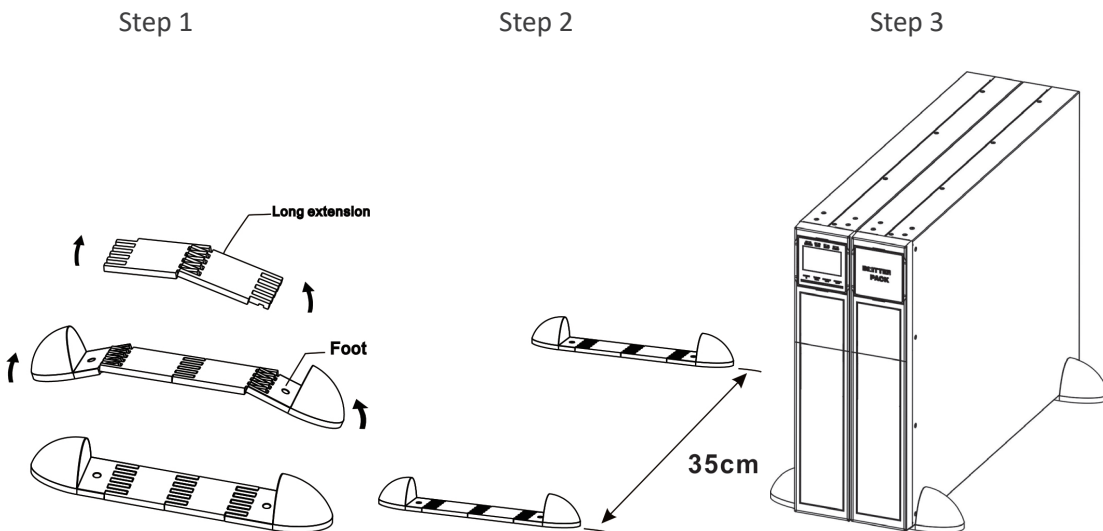

2.4 Rack Installation

Please follow below steps to mount UPS into 19" rack or rack enclosure.

Step 1: Attach mounting ears to the side mounting holes of UPS using the screws provided and the ears should face forward.

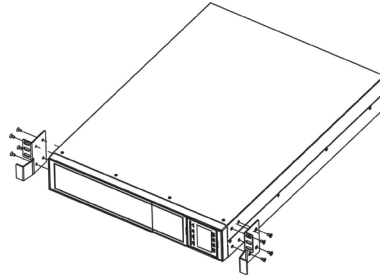

Step 2: Install the optional rack rail kits into the rack to support the UPS, Iso transformer module, and Battery Pack (one rail kit required for each piece).

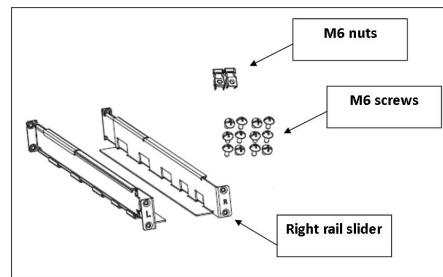

Step 2: Lift the UPS module and slide it into rack enclosure. Attach the UPS module to the rack with screws, nuts and washers (user-provided) through its mounting ears and into the rack rails.

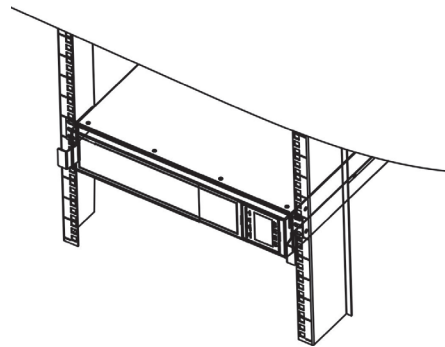

Step 4: Install the IT60A Iso Transformer module (if included) in the rack directly below the UPS, duplicating the UPS module instructions above

Step 5: Mount the XBDM-P91A or XBDM-P91B (if included) to the rear of the 1st external battery pack, using the included mounting bracket and screws.

Step 6: Install the External Battery Pack into the rack directly below the Iso Transformer module (if included), or directly below the UPS if the Iso Transformer module is not included. duplicating the UPS module instructions above

Step 7: install additional External Battery Packs (if included)

2.5 Battery Wiring Diagram

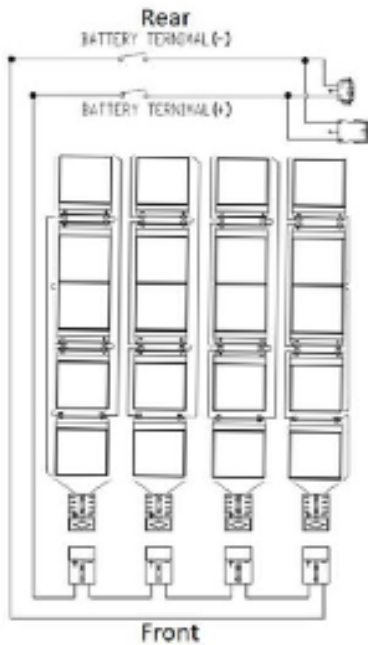

2U Battery Pack 240V
Figure 2-18

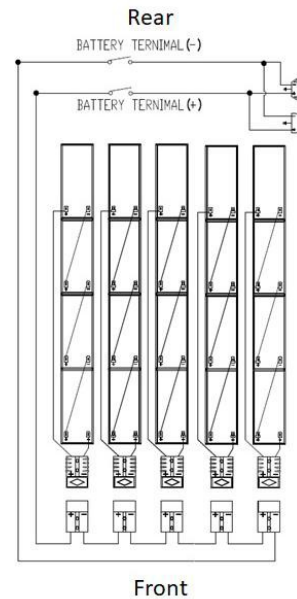

3U Battery Pack 240V
Figure 2-19

Type of Battery Required

These battery packs have been designed to operate with the following types of batteries:

2U battery pack: 240V/5Ah Version, 20 pieces of 12V 5Ah batteries

3U battery pack: 240V/580W Version, 20 pieces of 12V 580W batteries

2.6 Storage & Maintenance

The unit contains no user-serviceable parts. If the battery service life (3~5 years at 25°C ambient temperature) has been exceeded, the batteries must be replaced. In this case, please contact your dealer.

Storage

Before storing, charge the unit 4 hours. Store the unit covered and upright in a cool, dry location. During storage, recharge the battery in accordance with the following table:

Storage Temperature	Recharge Frequency	Charging Duration
-25°C - 40°C	Every 3 months	1-2 hours
40°C - 45°C	Every 2 months	1-2 hours

2.7 UPS Electrical Connections/Installation

Note: These instruction are for units whose inputs connect directly to utility. For units using a bypass, refer to the 'XBDM_XPD P91 Installation Addendum'.

Installation and wiring must be performed in accordance with the local electric laws/regulations and the following instructions must be performed by qualified personnel

1. Make sure the mains wire and breakers in the building are sized for the rated capacity of UPS to avoid the hazards of electric shock or fire.
2. Switch off the mains switch in the building before installation.
3. Turn off all the connected devices before connecting to the UPS.
4. Prepare wiring based on the following table:

Model	Nominal Input Currents			
	Input @208V in/out	Recommended Input OCP	Input @240V in/out	Recommended Input OCP
5K	25.8A	35A	22.4A	30A
6K	31.0A	40A	26.7A	35A
10K	51.7A	65A	44.8A	60A

It is recommended the install use 208V as basis of the installation in case the voltages used ever change.

NOTE: The selections for size and color of wires should follow the local electrical laws and regulations.

5. Remove the terminal block cover on the rear panel of UPS, connect the ground wire first, then connect the wires according to the following terminal block diagram: (Disconnect the ground wire last when making wire disconnection)

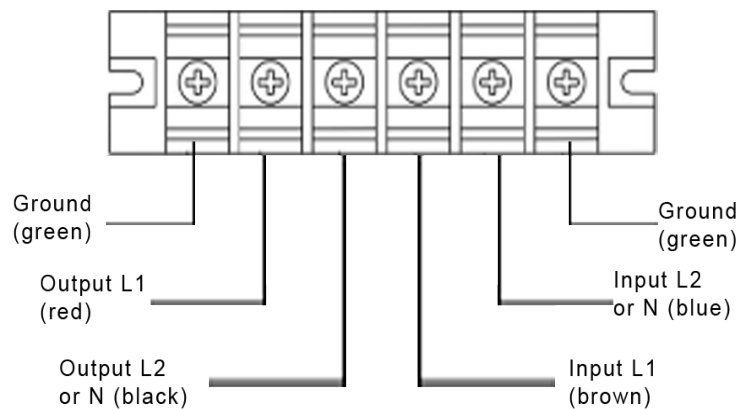

UPS Terminal Block to Anderson Connector wiring diagram
Figure 2-20

6. After connecting the wires, replace the terminal block cover on the rear panel of the UPS.
7. Ensure that the battery pack breaker is in the "OFF" position. Then connect the battery pack cable to the battery pack connector on the rear of the UPS. For additional battery packs, plug the battery pack cable into the empty connector on the rear of the previous battery pack

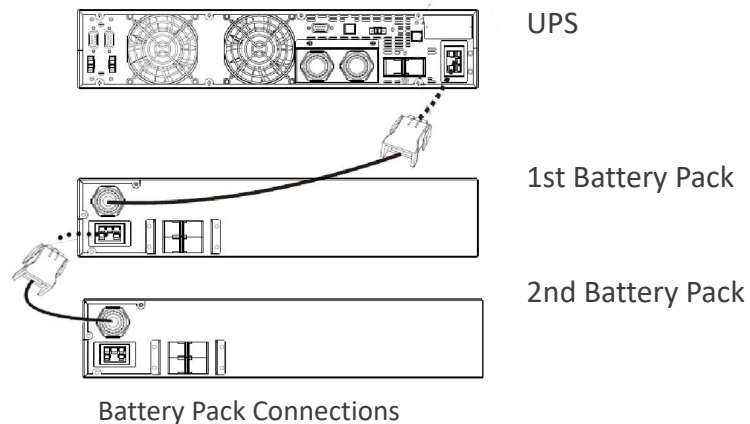

Figure 2-21

8. On the IT-60A Iso Transformer module, place the red switch in correct position. 208 for 208V installations and 240 for 240V installations. (Refer to figure 2-4)
9. Plug the power cord for the IT60A iso transformer module (if supplied) into one of the L6-30R receptacles on the XBDM-91A or XBDM-91B. (Refer to Figure 2-5)
10. Connect the External maintenance bypass switch wire on the XBDM-P91 to the External maintenance bypass switch port on the UPS. (Refer to figures 2-5 and 2-1)

NOTE 1: Make sure all wires are connected securely.

NOTE 2: Please install the output over current protection breaker between the output terminal and the load on hardwired systems. The breaker should be qualified with leakage current protective function if necessary.



Warning:

For standard battery pack, there is one DC breaker to disconnect the battery pack and the UPS. Switch off the battery breaker before installation. Make sure the utility input & output wiring, is correct. The wire current spec, color, position, connection and conductance reliability should be in accordance with local and national electrical code.

Software Installation

For optimal computer system protection, install UPS monitoring software to fully configure UPS shutdown. Refer to Viewpower CD.

3 Operation

3.1 User Interface

3.1.1 Button Operation

Button	Function
ON/Enter Button	Turn on the UPS: Press and hold the button more than 0.5s to turn on the UPS. Enter Key: Press this button to confirm the selection in setting menu.
OFF/ESC Button	Turn off the UPS: Press and hold the button more than 0.5s to turn off the UPS. Esc key: Press this button to return to last menu in setting menu.
Test/Up Button	Test/Up Button Battery test: Press and hold the button more than 0.5s to test the battery while in AC mode, or CVCF mode. UP key: Press this button to display next selection in setting menu.
Mute/Down Button	Mute the alarm: Press and hold the button more than 0.5s to mute the buzzer. Please refer to section 3-4-9 for details. Down key: Press this button to display previous selection in setting menu.
Test/Up + Mute/Down Button	Press and hold the two buttons simultaneously for more than 1s to enter/escape the setting menu.

* CVCF mode means converter mode.

3.1.2 LED Indicators

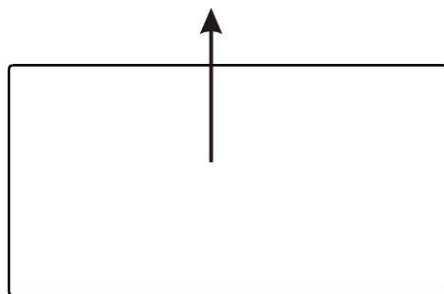

There are 4 LEDs on front panel to show the UPS working status:







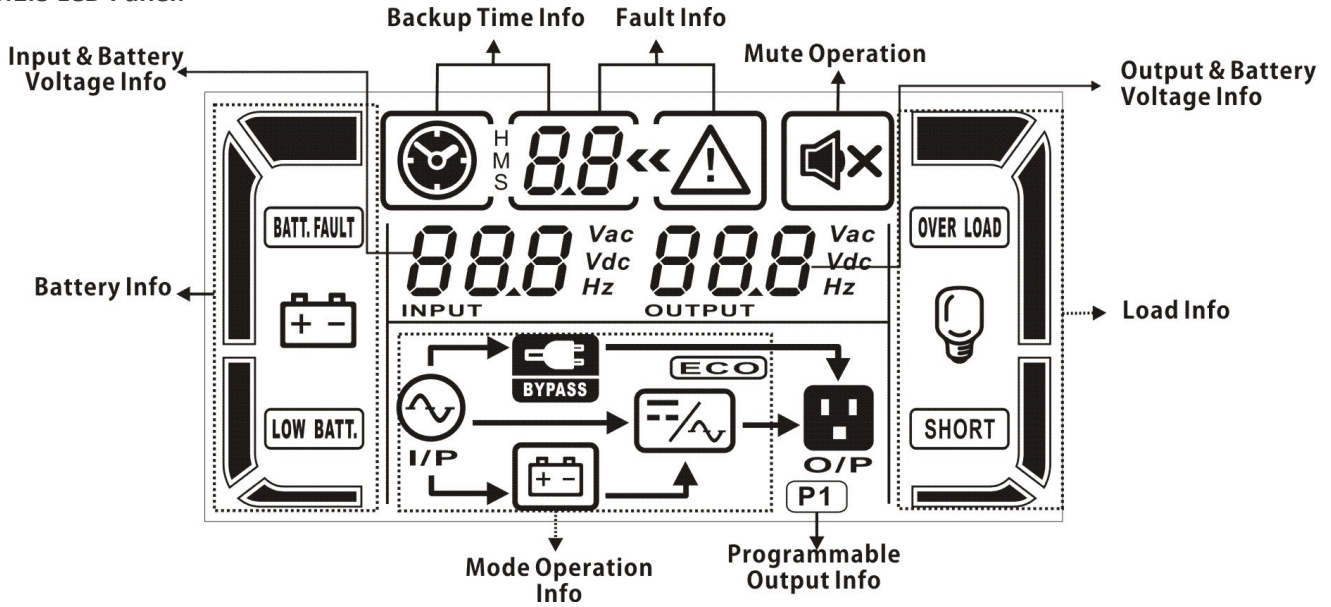



Mode	LED	Bypass	Line	Battery	Fault
UPS Startup		●	●	●	●
Bypass mode		●	○	○	○
AC mode		○	●	○	○
Battery mode		○	○	●	○
CVCF mode		○	●	○	○
Battery Test		●	●	●	○
ECO mode		●	●	○	○
Fault		○	○	○	●

Note: ● means LED is lighting, and ○ means LED is faded.

3.1.3 LCD Panel:



Display	Function
Backup time information	
	Indicates battery runtime remaining time in numbers H: hours, M: minutes, S: seconds
Fault information	
	Indicates that the warning and fault occurs.
	Indicates the fault codes, and the codes are listed in details in section 3-9.
Mute operation	
	Indicates that the UPS alarm is disabled.
Output & Battery voltage information	
	Indicates the output voltage, frequency or battery voltage. Vac: output voltage, Vdc: battery voltage, Hz: frequency
Load information	
	Indicates the load level by 0-25%, 26-50%, 51-75%, and 76-100%.
	Indicates overload.
	Indicates the load or the output is short.

Mode operation information	
	Indicates the UPS connects to the mains.
	Indicates the battery is working.
	Indicates the bypass circuit is working.
	Indicates the ECO mode is enabled.
	Indicates the Inverter circuit is working.
	Indicates the output is working.
Battery information	
	Indicates the Battery capacity by 0-25%, 26-50%, 51-75%, and 76-100%.
	Indicates the battery is not connected.
	Indicates low battery level and low battery voltage.
Input & Battery voltage information	
	Indicates the input voltage or frequency or battery voltage. Vac: Input voltage, Vdc: battery voltage, Hz: input frequency

3.1.4 Operating Mode/Status Description

If parallel UPS systems are successfully set up, it will show one more screen with “PAR” in parameter 2 and be assigned number in parameter 3 as below parallel screen diagram. The master UPS will be default assigned as “001” and slave UPSs will be assigned as either “002” or “003”. The assigned numbers may be changed dynamically in the operation.

Operating mode/status		
AC mode	Description	When the input voltage is within acceptable range, UPS will provide pure and stable AC power to output. The UPS will also charge the battery at AC mode.
	LCD display	
ECO mode	Description	When the input voltage is within voltage regulation range and ECO mode is enabled, UPS will bypass voltage to output for energy saving.
	LCD display	
CVCF mode	Description	When input frequency is within 46 to 64Hz, the UPS can be set at a constant output frequency, 50 Hz or 60 Hz. The UPS will still charge battery under this mode.
	LCD display	
Battery mode	Description	When the input voltage is beyond the acceptable range or power failure, UPS will backup power from battery and alarm will beep every 4 seconds.
	LCD display	
Bypass mode	Description	When input voltage is within acceptable range and bypass is enabled, turn off the UPS and it will enter Bypass mode. Alarm beeps every two minutes.
	LCD display	
Battery Test	Description	When UPS is in AC mode or CVCF mode, press "Test" button for more than 0.5s. Then the UPS will beep once and start "Battery Test". The line between I/P and inverter icons will blink to remind users. This operation is used to check the battery status.

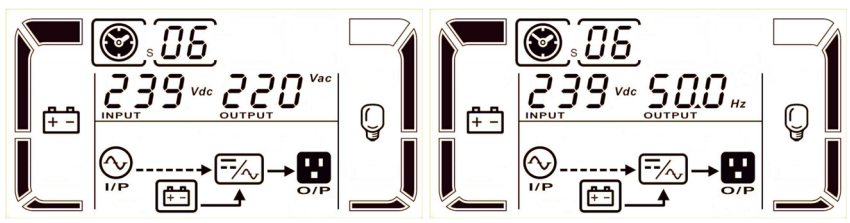
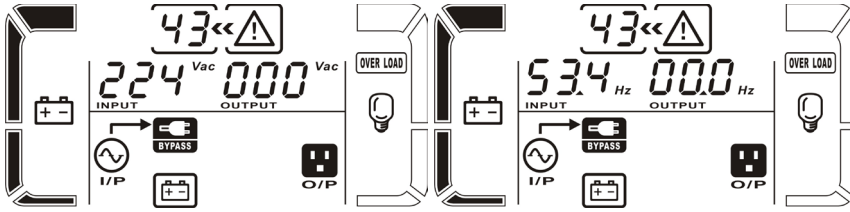
	LCD display	
Fault status	Description	When UPS has fault happened, it will display fault messages in LCD panel.
	LCD display	

3.2 UPS Operation

Turn on the UPS with utility power supply (in AC mode)

- 1) After power supply is connected correctly, set the breaker of the battery pack at "ON" position. Then set the input breaker at "ON" position. At this time the fan is running and the UPS supplies power to the loads via the bypass. The UPS is operating in Bypass mode.

NOTE: When UPS is in Bypass mode, the output voltage will directly power from utility after you switch on the input breaker. In Bypass mode, the load is not protected by UPS. To protect your precious devices, you should turn on the UPS. Refer to next step.

- 2) Press and hold the "ON" button for 0.5s to turn on the UPS and the buzzer will beep once.
- 3) A few seconds later, the UPS will enter to AC mode. If the utility power is abnormal, the UPS will operate in Battery mode without interruption.

NOTE: When the UPS is running out battery, it will shut down automatically at Battery mode. When the utility power is restored, the UPS will auto restart.

Turn on the UPS without utility power supply (in Battery mode)

- 1) Make sure that the breaker of the battery pack is at "ON" position.
- 2) Press and hold the "ON" button for 0.5s to turn on the UPS, and the buzzer will beep once.
- 3) A few seconds later, the UPS will be turned on and enter to Battery mode.

Connect devices to UPS

After the UPS is turned on, you can connect devices to the UPS.

- 1) Turn on the UPS first and then switch on the devices one by one, the LCD panel will display total load level.
- 2) If it is necessary to connect the inductive loads such as a printer, the in-rush current should be calculated carefully to see if it meets the capacity of the UPS, because the power consumption of this kind of loads is too big.
- 3) If the UPS is overloaded, the buzzer will beep twice every second.
- 4) When the UPS is overloaded, please remove some loads immediately. It is recommended to have the total loads connected to the UPS less than 80% of its nominal power capacity to prevent overload for system safety.
- 5) If the overload time is over acceptable time listed in spec at AC mode, the UPS will automatically transfer to Bypass mode. After the overload is removed, it will return to AC mode. If the overload time is over acceptable time listed in spec at Battery mode, the UPS will become fault status. At this time, if

Charge the batteries

- 1) After the UPS is connected to the utility power, the charger will charge the batteries automatically except in Battery mode or during battery self-test.
- 2) Suggest to charge batteries at least 10 hours before use. Otherwise, the backup time may be shorter than expected time.
- 3) Make sure the battery numbers setting on the control board (Please refer to the section 3-4-12 for detailed setting) is consistent to real connection.

Battery mode operation

1. When the UPS is in Battery mode, the buzzer will beep according to different battery capacity. If the battery capacity is more than 25%, the buzzer will beep once every 4 seconds; If the battery voltage drops to the alarm level, the buzzer will beep quickly (once every sec) to remind users that the battery is at low level and the UPS will shut down automatically soon. Users could switch off some non-critical loads to disable the shutdown alarm and prolong the backup time (the UPS would cut off the programmable output terminal automatically when the programmable timer function is enabled). If there is no more load to be switched off at that time, you have to shut down all loads as soon as possible to protect the devices or save data. Otherwise, there is a risk of data loss or load failure.

Test the batteries

1. If you need to check the battery status when the UPS is running in AC mode/CVCF mode/ECO mode, you could press the "Test" button to let the UPS do battery self-test.
2. To keep the system reliable, the UPS will perform the battery self-test automatically periodically. The default setting period is once per week.
3. Users also can set battery self-test through monitoring software.
4. If the UPS is at battery self-test, the LCD display and buzzer indication will be the same as at Battery mode except that the battery LED is flashing.

Turn off the UPS with utility power supply in AC mode

- 1) Turn off the inverter of the UPS by pressing "OFF" button for at least 0.5s, and then the buzzer will beep once. The UPS will turn into Bypass mode.

NOTE 1: If the UPS has been set to enable the bypass output, it will bypass voltage from utility power to output sockets and terminal even though you have turned off the UPS (inverter).

NOTE 2: After turning off the UPS, please be aware that the UPS is working at Bypass mode and there is risk of power loss for connected devices.

- 2 In Bypass mode, output voltage of the UPS is still present. In order to cut off the output, switch off the input breaker. A few seconds later, there is no display shown on the display panel and UPS is complete off.

Turn off the UPS without utility power supply in Battery mode

1. Turn off the UPS by pressing "OFF" button for at least 0.5s, and then the buzzer will beep once.
2. Then UPS will cut off power to output and there is no display shown on the display panel.

Mute the buzzer

1. To mute the buzzer, please press the "Mute" button for at least 0.5s. If you press it again after the buzzer is muted, the buzzer will beep again.
2. Some warning alarms can't be muted unless the error is fixed.

Operation in warning status

1. When Fault LED flashes and the buzzer beeps once every second, it means that there are some problems for UPS operation. Users can get the fault code from LCD panel. Please check the trouble shooting table in section 4 for details.

Operation in Fault mode

1. When Fault LED illuminates and the buzzer beeps continuously, it means that there is a fatal error in the UPS. Users can get the fault code from display panel. Please check the trouble shooting table in section 4 for details.
2. Please check the loads, wiring, ventilation, utility, battery and so on after the fault occurs. Don't try to turn on the UPS again before solving the problems. If the problems can't be fixed, please contact the distributor or service people immediately.
3. For emergency case, please cut off the connection from utility, external battery, and output immediately to avoid more risk or danger.

Adjusting charging current:

1. In bypass mode, press "Test/UP" button and "Mute/Down" button simultaneous for more than 1s to enter the setting menu.
2. Press the "Mute/Down" button until it shows 17 in parameter 1 and press "Enter" button to adjust the charging current. (Check 3-7 LCD setting for the details.)

Number of battery packs	Recommended Charge Current setting		
	Quantity (1)	Quantity (2)	Quantity (3)
2U Battery Pack	1	1.5	2
3U Battery Pack	1.5	3	4

3. In parameter 2, you can select the charging current from 1A to 4A by pressing "Test/UP" button or "Mute/ Down" button. Please confirm the setting by pressing "ON/Enter" button.
4. In parameter 3, it is to adjust the charging current according to the deviation between the actual charging current and the setting value of the current.

For example, you want to have the charging current in 4A, but in fact, the charging current is measured only 3.6A. Then, you need to select "+" and change the number to 4 in parameter 3. It means the setting charging current will be added 0.4A as output charging current. Then, confirm this modification by pressing "ON/Enter" button. Now, you may press "Test/UP" and "Mute/Down" buttons at the same time to exit the setting mode.

NOTE 1: Be careful that the maximum charging current should not exceed the battery accepted charging current.

NOTE 2: All parameter settings will be saved only when UPS shuts down normally with internal or external battery connection. (Normal UPS shutdown means turning off input breaker in bypass/no output mode).

Abbreviation Meaning in LCD Display

Abbreviation	Display content	Meaning
ENA	ENR	Enable
DIS	diS	Disable
ATO	AtO	Auto
BAT	bAt	Battery
NCF	nCF	Normal mode (not CVCF mode)
CF	CF	CVCF mode
SUB	SUB	Subtract
ADD	Add	Add
ON	ON	On
OFF	OFF	Off
FBD	Fbd	Not allowed
OPN	OPN	Allow
RES	RES	Reserved
OP.V	OP.V	Output voltage
PAR	PAR	Parallel

3.3 LCD Settings

There are three parameters to set up the UPS. Refer to following diagram.

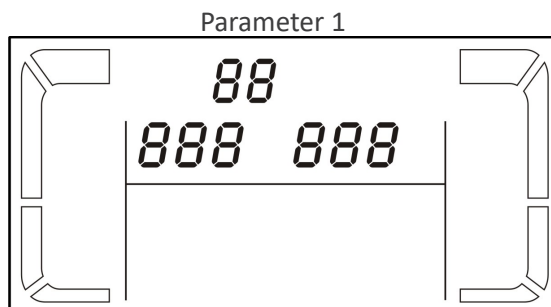

Parameter 1: Displays program alternatives

Parameter 2 and parameter 3 are the setting options or values for each program.

How to set parameters

1. Put the UPS in Bypass mode by pressing and holding the OFF/ESC button for over 5 seconds.
2. Press and hold the Test/Up + Mute/Down buttons simultaneously. To enter setting mode.
3. Use the Up or Down button to find the ups parameter you wish to set.
4. Press the Enter button to confirm the selection
5. Use the Up or Down button to select the desired value.
6. Press the Enter button to confirm the selection
7. Press and hold the Text/Up + Mute/Down buttons simultaneously. To exit setting mode.
8. Cycle UPS input power to save settings.

Programs available list for parameter 1:

Code	Description	Bypass/ No output	AC	ECO	CVCF	Battery	Battery Test
01	Output voltage	Y					
02	Output frequency	Y					
03	Voltage range for bypass	Y					
04	Frequency range for bypass	Y					
05	ECO mode enable/disable	Y					
06	Voltage range for ECO mode	Y					
07	ECO mode frequency range setting	Y					
08	Bypass mode setting	Y	Y				
09	Battery backup time setting	Y	Y	Y	Y	Y	Y
10	Reserved	Reserved for future					
11	Reserved	Reserved for future					
12	Hot standby function en- able/disable	Y	Y	Y	Y	Y	Y
13	Battery voltage adjustment	Y	Y	Y	Y	Y	Y
14	Charger voltage adjustment	Y	Y	Y	Y	Y	Y
15	Inverter voltage adjustment		Y		Y	Y	
16	Output voltage calibration		Y		Y	Y	
17	Charging current setting	Y	Y	Y	Y	Y	Y



*Y means that this program can be set in this mode.

Note: All parameter settings will be saved only when UPS shuts down normally with internal or external battery connection. (Normal UPS shutdown means turning off input breaker in bypass/no output mode).

01: Output voltage

Interface	Setting
	<p>Parameter 3: Output voltage You may choose the following output voltage in parameter 3: 208: Presents output voltage is 208Vac 220: Presents output voltage is 220Vac 230: Presents output voltage is 230Vac 240: Presents output voltage is 240Vac</p>

02: Output frequency

Interface	Setting
<p>60 Hz, CVCF mode</p> 	<p>Parameter 2: Output Frequency Setting the output frequency. You may choose following three options in parameter 2: 50.0Hz: The output frequency is setting for 50.0Hz. 60.0Hz: The output frequency is setting for 60.0Hz. ATO: If selected, output frequency will be decided according to the latest normal utility frequency. If it is from 46Hz to 54Hz, the output frequency will be 50.0Hz. If it is from 56Hz to 64Hz, the output frequency will be 60.0Hz. ATO is default setting.</p>
<p>50 Hz, Normal mode</p> 	<p>Parameter 3: Frequency mode Setting output frequency at CVCF mode or not CVCF mode. You may choose following two options in parameter 3: CF: Setting UPS to CVCF mode. If selected, the output frequency will be fixed at 50Hz or 60Hz according to setting in parameter 2. The input frequency could be from 46Hz to 64Hz.</p>
<p>ATO</p> 	<p>NCF: Setting UPS to normal mode (not CVCF mode). If selected, the output frequency will synchronize with the input frequency within 46~54 Hz at 50Hz or within 56~64 Hz at 60Hz according to setting in parameter 2. If 50 Hz selected in parameter 2, UPS will transfer to battery mode when input frequency is not within 46~54 Hz. If 60Hz selected in parameter 2, UPS will transfer to battery mode when input frequency is not within 56~64 Hz.</p>
<p>*If Parameter 2 is ATO, the Parameter 3 will show the current frequency.</p>	

Note: If the UPS is set to CVCF mode, the bypass function will be disabled automatically.

But when a single UPS is powered on with mains and before the UPS has finished the startup, there will be a few seconds of voltage pulse (same as the input voltage) on the bypass output.

If you need to remove the pulse on this mode to protect your load better, you could contact the dealer for help.

03: Voltage range for bypass

Interface	Setting
	<p>Parameter 2: Set the acceptable low voltage for bypass. Setting range is from 110V to 209V and the default value is 110V.</p> <p>Parameter 3: Set the acceptable high voltage for bypass. Setting range is from 231V to 276V and the default value is 264V.</p>

04: Frequency range for bypass

Interface	Setting
	<p>Parameter 2: Set the acceptable low frequency for bypass. 50 Hz system: Setting range is from 46.0Hz to 49.0Hz. 60 Hz system: Setting range is from 56.0Hz to 59.0Hz. The default value is 46.0Hz/56.0Hz.</p> <p>Parameter 3: Set the acceptable high frequency for bypass. 50 Hz: Setting range is from 51.0Hz to 54.0 Hz. 60 Hz: Setting range is from 61.0Hz to 64.0Hz. The default value is 54.0Hz/64.0Hz.</p>

05: ECO mode enable/disable

Interface	Setting
	<p>Parameter 3: Enable or disable ECO function. You may choose following two options: DIS: disable ECO function ENA: enable ECO function</p> <p>If ECO function is disabled, voltage range and frequency range for ECO mode still can be set, but it is meaningless unless the ECO function is enabled.</p>

06: Voltage range for ECO mode

Interface	Setting
	<p>Parameter 2: Low voltage point in ECO mode. The setting range is from 5% to 10% of the nominal voltage.</p> <p>Parameter 3: High voltage point in ECO mode. The setting range is from +5% to +10% of the nominal voltage.</p>
	<p>Parameter 3: High voltage point in ECO mode. The setting range is from 5% to 10% of the nominal voltage.</p>

07: Frequency range for ECO mode

Interface	Setting
	<p>Parameter 2: Set low frequency point for ECO mode. 50 Hz system: Setting range is from 46.0Hz to 49.0Hz. 60 Hz system: Setting range is from 56.0Hz to 59.0Hz. The default value is 48.0Hz/58.0Hz.</p> <p>Parameter 3: Set high frequency point for ECO mode. 50 Hz: Setting range is from 51.0Hz to 54.0 Hz. 60 Hz: Setting range is from 61.0Hz to 64.0Hz. The default value is 52.0Hz/62.0Hz.</p>

08: Bypass mode setting

Interface	Setting
	<p>Parameter 2: OPN: Bypass allowed. When selected, UPS will run at Bypass mode depending on bypass enabled/disabled setting. FBD: Bypass not allowed. When selected, it's not allowed for running in Bypass mode under any situations.</p> <p>Parameter 3: ENA: Bypass enabled. When selected, Bypass mode is activated. DIS: Bypass disabled. When selected, automatic bypass is acceptable, but manual bypass is not allowed. Manual bypass means users manually operate UPS for Bypass mode. For example, pressing OFF button in AC mode to turn into Bypass mode.</p>

09: Battery backup time setting

Interface	Setting
	<p>Parameter 3: 000~999: Set the maximum backup time from 0min to 999min. UPS will shut down to protect battery after backup time arrives. The default value is 990min. DIS: Disable battery discharge protection and backup time will depend on battery capacity.</p>

10: Reserved

Interface	Setting
	<p>Reserved</p>

11: Reserved

Interface	Setting
<p>The LCD display shows '11<<' at the top and 'RES RES' in the middle. The display is framed by a yellow border.</p>	<p>Reserved</p>

12: Hot standby function enable/disable

Interface	Setting
<p>The LCD display shows '12<<' at the top and 'HS.H YES' in the middle. The display is framed by a yellow border.</p>	<p>Parameter 2: HS.H Enable or disable Hot standby function. You may choose following two options in Parameter 3: YES: Hot standby function is enabled. It means that the current UPS is set to host of the hot standby function, and it will restart after AC recovery even without battery connected. NO: Hot standby function is disabled. The UPS is running at normal mode and can't restart without battery</p>

13: Battery voltage adjustment

Interface	Setting
<p>The LCD display shows '13<<' at the top and 'Add 0.18 Vdc' in the middle. A battery icon is visible at the bottom of the display area. The display is framed by a yellow border.</p>	<p>Parameter 2: Select "Add" or "Sub" function to adjust battery voltage to real figure. Parameter 3: the voltage range is from 0V to 5.7V, the default value is 0V.</p>

14: Charger voltage adjustment

Interface	Setting
<p>The LCD display shows '14<<' at the top and 'Add 0.26 Vdc' in the middle. A battery icon and an AC input icon are visible at the bottom of the display area. The display is framed by a yellow border.</p>	<p>Parameter 2: you may choose Add or Sub to adjust charger voltage Parameter 3: the voltage range is from 0V to 9.9V, the default value is 0V. NOTE: *Before making voltage adjustment, be sure to disconnect all batteries first to get the accurate charger voltage. *We strongly suggest to use the default value (0). Any modification should be suitable to battery specifications.</p>

15: Inverter voltage adjustment

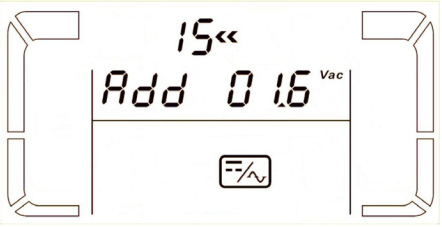
Interface	Setting
	Parameter 2: you may choose Add or Sub to adjust inverter voltage Parameter 3: the voltage range is from 0V to 6.4V, the default value is 0V.

16: Output voltage adjustment

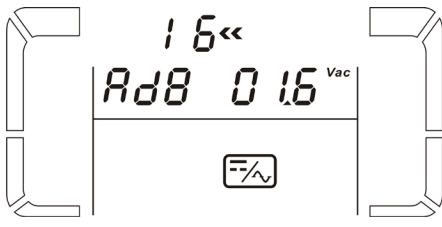
Interface	Setting
	Parameter 2: You may choose Add or Sub to adjust Output voltage. Parameter 3: The voltage range is from 0V to 6.4V and the default value is 0V.

17: Charging current setting

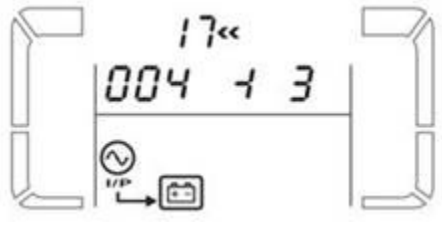
Interface	Setting
	Parameter 2: Set up charging current of the charger 001~004: Set the charging current of the charger from 1A to 4A. Parameter 3: Calibrate the charging current. ± 0~± 5: You may choose '+' as add or '-' as Sub to adjust charging current. This setting number is the first number after the decimal point. For example, if setting value is "+" and "3", it means the calibrated formula is to add 0.3A. The setting charging current on the left screen is 4.3A. (4A + 0.3A = 4.3A.)









4 Trouble Shooting

4.1 Audible Alarm

If the UPS system is not functioning correctly, please reference the tables below to isolate the issue.

Description	Buzzer status
UPS status	
Bypass mode	Beeping once every 2 minutes
Battery mode	Beeping once every 4 seconds
Fault Mode	Beeping continuously
Warning	
Overload	Beeping twice every second
Others	Beeping once every second
Fault	
All	Beeping continuously

4.2 Warning Indicators

Warning	Icon (flashing)	Alarm
Battery low		Beeping every second
Overload		Beeping twice every second
Battery unconnected		Beeping every second
Over charge		Beeping every second
EPO enable		Beeping every second
Fan failure/Over temperature		Beeping every second
Charger failure		Beeping every second
I/P fuse broken		Beeping every second
Overload 3 times in 30min		Beeping every second









4.3 Warning Code Descriptions

Warning code	Warning event	Warning code	Warning event
01	Battery unconnected	10	L1 IP fuse broken
07	Over charge	21	Line situations are different in parallel system
08	Low battery	22	Bypass situations are different in parallel system
09	Overload	33	Locked in bypass after overload 3 times in 30min
0A	Fan failure	3A	Cover of maintain switch is open
0B	EPO enable	3D	Bypass unstable
0D	Over temperature	3E	Boot loader is missing
0E	Charger failure		

4.4 Fault Code Descriptions

Fault event	Fault code	Icon	Fault event	Fault code	Icon
Bus start failure	01	None	Battery SCR short circuited	21	None
Bus over	02	None	Inverter relay short circuited	24	None
Bus under	03	None	Charger short circuited	2a	None
Bus unbalance	04	None	Can communication fault	31	None
Inverter soft start failure	11	None	Parallel output current unbalance	36	None
High Inverter voltage	12	None	Over temperature	41	None
Low Inverter voltage	13	None	CPU communication failure	42	None
Inverter output short circuited	14	SHORT	Overload	43	OVER LOAD
Negative power fault	1A	None	Battery turn-on failure	6A	None
Inverter over current	60	None	PFC current failure in battery mode	6B	None
Inverter waveform abnormal	63	None	Bus voltage changes too fast	6C	None

4.5 Troubleshooting Chart

Symptom	Possible cause	Remedy
The icon  and the warning code <i>EP</i> flash on LCD display and alarm beeps every second.	EPO function is enabled.	Set the circuit in closed position to disable EPO function.
The icon  and  flash on LCD display and alarm beeps every second.	The external or internal battery is incorrectly connected.	Check if all batteries are connected well.
The icon  and  flash on LCD display and alarm beeps twice every second.	UPS is overloaded.	Remove excess loads from UPS output.
	UPS is overloaded. Devices connected to the UPS are fed directly by the electrical network via the Bypass.	Remove excess loads from UPS output.
	After repetitive overloads, the UPS is locked in the Bypass mode. Connected devices are fed directly by the mains.	Remove excess loads from UPS output first. Then shut down the UPS and restart it.
Fault code is shown as 43. The icon  lights on LCD display and alarm beeps continuously.	UPS is overloaded too long and becomes fault. Then UPS shut down automatically.	Remove excess loads from UPS output and restart it.
Fault code is shown as 14, the icon  lights on LCD display, and alarm beeps continuously.	The UPS shut down automatically because short circuit occurs on the UPS output.	Check output wiring and if connected devices are in short circuit status.
Fault code is shown as 01, 02, 03, 04, 11, 12, 13, 14,1A, 21, 24, 35, 36, 41, 42 or 43 on LCD display and alarm beeps continuously.	A UPS internal fault has occurred. There are two possible results: 1. The load is still supplied, but directly from AC power via bypass. 2. The load is no longer supplied by power.	Contact your dealer.
Battery backup time is shorter than nominal value	Batteries are not fully charged	Charge the batteries for at least 7 hours and then check capacity. If the problem still persists, consult your dealer.
	Batteries defect	Contact your dealer to replace the battery.
The icon  and  flash on LCD display and alarm beeps every second.	Fan is locked or not working; or the UPS temperature is too high.	Check fans and notify dealer.

5 Specifications

MODEL NUMBER		P91-5K	P91-6K	P91-10K
CAPACITY	Power rating	5kVA (5kW)	6kVA (6kW)	10kVA (10kW)
INPUT	Voltage	110–300VAC*		
	Frequency	50/60Hz		
OUTPUT	Voltage	200/208/220/230/240VAC (208/120V or 240/120V with optional transformer)		
	Frequency	50/60Hz ± 4Hz		
	THD (full load)	< 4%		
	Overload capacity	110% 10 min; 130% 1 min; > 130% 1 sec		
	Efficiency	Up to 95% online mode or 99% ECO mode		
BATTERY	Charger amps	1–4A		
	Nominal/float voltage	240/273VDC		
DIMENSIONS & WEIGHT	Dimensions (W x D x H)	17.2 x 23.6 x 3.5 in		
	Weight	33.1 lbs		39.7 lbs
BYPASS DISTRIBUTION MODULE	Model	XBDM-P91A	XBDM-P91B	
	Input connection	L6–30P (5, 6kVA)	Terminal Block (5,6,10kVA)	
	Output connection	(2) L6-30R+(2) C19 Optional: L6–30R, L6–20R, 6–20R	Terminal block + (1) L6-30R+(2) C19 Optional: L6–30R, L6–20R, 6–20R	
ENVIRONMENT	Operating temperature	32–104°F (0–40°C)		
	Audible noise	< 55dBA		< 58dBA
	Altitude	11,500 ft above sea level		
APPROVALS	UL, FCC, RoHS (pending)			
WARRANTY	3 years electronics, 3 years battery warranty (USA and Canada)			
COMMUNICATIONS INTERFACE	RS-232, USB, EPO, intelligent slot for optional cards (Web/SNMP, Relay/dry contact, Modbus)			
INCLUDED IN BOX	Software CD, horizontal brackets, tower pedestals, USB cable			
AVAILABLE OPTIONS	5 year extended warranty, 4-post rail kit, 2-post shelf kit, transformer			

*Depending on load level.

6 Obtaining Service

If the UPS requires Service:

1. Use the TROUBLESHOOTING section in this manual to eliminate obvious causes.
2. Verify there are no circuit breakers tripped.
3. Call your dealer for assistance. If you cannot reach your dealer, or if they cannot resolve the problem, call Xtreme Power Conversion Corp Technical Support at 800.582.4524. Technical support inquiries can also be made at support@xpcc.com. Please have the following information available BEFORE calling the Technical Support Department:
 - Your name and address.
 - The serial number of the unit.
 - Where and when the unit was purchased.
 - All of the model information about your UPS.
 - Any information on the failure, including LED's that may or may not be illuminated.
 - A description of the protected equipment, including model numbers if possible.
 - A technician will ask you for the above information and, if possible, help solve your problem over the phone. In the event that the unit requires factory service, the technician will issue you a Return Material Authorization number (RMA).

If you are returning the UPS to Xtreme Power for service, please follow these procedures:

1. Pack the UPS in its original packaging. If the original packaging is no longer available, ask the Technical Support Technician about obtaining a replacement set of packaging material. It is important to pack the UPS properly in order to avoid damage in transit. Never use Styrofoam beads for a packing material.
2. Include a letter with your name, address, daytime phone number, RMA number, a copy of your original sales receipt, and a brief description of the problem.
3. Mark the RMA number on the outside of all packages. Xtreme Power cannot accept any package without the RMA number marked on the outside of the boxes.
4. Return the UPS by insured, prepaid carrier to the address provided by the Technician.
5. Refer to the Warranty statements in this manual for additional details on what is covered.

7 Xtreme Power Conversion Limited Warranty

Xtreme Power Conversion (XPC) Corporation warrants Xtreme Power Conversion equipment, when properly applied and operated within specified conditions, against faulty materials or workmanship for a period of **three years for P91-Series products** from the date of purchase. XPC Corporation warrants **internal batteries for a period of three years** from the date of purchase. For equipment sites within the United States and Canada, this warranty covers repair or replacement, at the sole discretion of XPC Corporation. The customer is responsible for the costs of shipping the defective product to XPC Corporation. XPC Corporation will pay for ground shipment of the repaired or replacement product. This warranty applies only to the original purchaser.

If equipment provided by XPC Corporation is found to be **Dead-on-Arrival (DOA)**, XPC Corporation will be responsible for the costs of shipping product to and returning equipment from the customer in a timely manner as agreed to with the customer, once the customer has requested and received a **Return Material Authorization (RMA)** number. DOA equipment is defined as equipment that does not properly function according to user documentation when initially received and connected in conjunction with proper procedures as shown in the user documentation or via support provided by XPC Corporation personnel or authorized agents.

This warranty shall be void if (a) the equipment is repaired or modified by anyone other than XPC Corporation or a XPC Corporation approved third party; (b) the equipment is damaged by the customer, is improperly used or stored, is subjected to an adverse operating environment, or is operated outside the limits of its electrical specifications; or (c) the equipment has been used or stored in a manner contrary to the equipment's operating manual, intended use or other written instructions. Any technical advice furnished by XPC Corporation or a XPC Corporation authorized representative before or after delivery with regard to the use or application of Xtreme Power Conversion equipment is furnished on the basis that it represents XPC Corporations best judgment under the situation and circumstances, but it is used at the recipient's sole risk.

EXCEPT AS STATED ABOVE, XPC Corporation DISCLAIMS ALL WARRANTIES, EXPRESSED OR IMPLIED, INCLUDING WARRANTIES OF MERCHANTABILITY AND FITNESS FOR A PARTICULAR PURPOSE.

EXCEPT AS STATED ABOVE, IN NO EVENT WILL XPC Corporation BE LIABLE FOR DIRECT, INDIRECT, SPECIAL, INCIDENTAL, OR CONSEQUENTIAL DAMAGES ARISING OUT OF THE USE OF Xtreme Power Conversion EQUIPMENT, including but not limited to, any costs, lost profits or revenue, loss of equipment, loss of use of equipment, loss of software, loss of data, cost of substitutes, or claims by third parties. Purchaser's sole and exclusive remedy for breach of any warranty, expressed or implied, concerning Xtreme Power Conversion equipment, and the only obligation of XPC Corporation under this warranty, shall be the repair or replacement of defective equipment, components, or parts; or, at XPC Corporations sole discretion, refund of the purchase price or substitution of an equivalent replacement product.

8 Xtreme Power Conversion Load Protection Policy

THIS POLICY IS NOT A WARRANTY. REFER TO **THE XPC CORPORATION, INC. LIMITED WARRANTY** FOR INFORMATION CONCERNING THE WARRANTY FOR YOUR XPC PRODUCT. THE LIMITATIONS AND CONDITIONS CONTAINED IN THIS POLICY DO NOT AFFECT **THE TERMS OF THE XPC LIMITED WARRANTY**.

Definitions:

1. "Product" means a Standard 120, 208, or 240 Volt power protection device that is used in the United States and Canada. This policy does not include custom manufactured products.
2. "Power Disturbance" means an AC power line transient (telephone line or Local Area Network, if applicable), spike or surge.
3. "Connected Equipment" properly connected electronic equipment
4. "Fair Market Value" of damaged Connected Equipment as determined by XPC shall be the lower of (a) the average price the same or similar items are being sold for on eBay, (b) the price list of Orion Blue Book (or if such price list is no longer published, a published or announced price list reasonably selected by XPC), (c) the lowest price the same or similar items can be purchased for in the United States or (d) the total amount of all payment(s) you have or are entitled to receive from insurance, other warranties, extended warranties, a legal liability claim or from other sources or persons for the damaged Connected Equipment.
5. "Purchaser" means the person or entity that originally purchased the Product from an authorized reseller or distributor of XPC Products.

The Purchaser of this Product is protected, for the term of the XPC Limited Warranty, against certain losses caused by a Power Disturbance for properly connected electronic equipment (referred to as the "Connected Equipment") subject to certain terms and conditions provided below.

This policy applies only to the original purchaser of the Product. If the Product is transferred or sold to another person or entity, this policy is void.

Load Protection Policy Dollar and Period Limits

For purchasers that meet the qualifications and conditions set forth in this policy, XPC will provide reimbursement (cost of repair or fair market value as determined by XPC) during the period limits and up to the dollar limits stated as follows:

PRODUCT	DOLLAR LIMIT	PERIOD OF COVERAGE
XVT	25,000	Term of XPC Limited Warranty
XST	25,000	Term of XPC Limited Warranty
S70	25,000	Term of XPC Limited Warranty
XPRT 6kVA & 10kVA	50,000	Term of XPC Limited Warranty
NXRT	50,000	Term of XPC Limited Warranty
P90, P90L, P90g, P90Lg, P91	50,000	Term of XPC Limited Warranty
T90	50,000	Term of XPC Limited Warranty
TX90, TX90i	50,000	Term of XPC Limited Warranty

This Load Protection Policy is not deemed "first dollar" coverage. XPC's obligation is reduced by any amounts that the Purchaser is entitled to recover, from other sources regarding the Connected Equipment, including, but not limited to, insurance, other warranty, extended warranty, or legal liability, regardless of whether or not the Purchaser makes a claim for recovery.

Eligibility for Coverage Under the Load Protection Policy

1. The Product must be registered on the XPC website, www.xpcc.com, within 10 days of purchase. All required information must be provided, and Purchaser should retain a copy for Purchaser's records. When registering on the website, Purchaser must list all connected equipment that is directly connected to the

product. Only those devices registered in that manner will be covered.

2. All Connected Equipment must be UL or CSA approved.
3. The Product must be plugged into a properly wired and grounded outlet. Use of input surge devices, extension cords, adapters, ground wires, or electrical connections not manufactured by XPC voids the XPC Load Protection Policy. No other surge protection device may be connected to the output sockets of the Product. The installation must comply with all applicable electrical and safety codes set forth pursuant to the NEC.
4. The Product must have undeniable physical evidence of a Power Disturbance that directly and proximately caused the damage;
5. The Connected Equipment must have been damaged by a Power Disturbance on a properly installed, grounded, and National Electric Code, ("NEC"), code-compliant 120, 208, 240 Volt AC power line in the United States or Canada, by a Power Disturbance on standard telephone land line or PBX telephone equipment line that is properly installed and connected to an RJ11 port on the Product; or by a Power Disturbance on a standard Local Area Network connection that is properly installed and connected to an RJ45 port on the Product and (d) is directly plugged into, and properly connected to, the Product in its original condition which was properly operated when a Power Disturbance passed through the Product and (i) exhausts the protection capacity of the Product or (ii) damages the Product.
6. The Load Protection Policy does not apply if the Product has been operated in a failure mode or not in compliance with XPC operating instructions in the Product user's manual, or if the Connected Equipment has not been operated in compliance with the instructions and manuals of its manufacturer/vendor.
7. This policy is null and void if, XPC determines, in its sole discretion, that the Product has been tampered with or altered in any way.

What is Not Covered Under the Load Protection Policy:

The following damage is not covered by this Policy:

1. Restoration of lost data and reinstallation of software.
2. Damage from a cause other than AC power-line transients, except for damage due to telephone line, Local Area Network, or CATV transients, which is covered only if the Product offers such protection.
3. DAMAGE CAUSED BY FAILURE TO PROVIDE A SUITABLE INSTALLATION ENVIRONMENT FOR THE PRODUCT (INCLUDING, BUT NOT LIMITED TO, LACK OF A PROPER SAFETY GROUND).
4. Damage caused by the use of the Product for purposes other than those for which it was designed.
5. Damage caused by accidents, or natural disasters, including but not limited to, fire, flood, and wind.
6. Damage caused by abuse, misuse, alteration, modification, or negligence.
7. Any labor costs or travel, room and board expenses associated with the repair and/or restoration of lost or damaged hardware, software or data.

EXCEPT AS EXPRESSLY PROVIDED IN THIS POLICY, XPC SHALL NOT BE LIABLE FOR ANY DAMAGES WHATSOEVER, INCLUDING, BUT NOT LIMITED TO, DIRECT, INDIRECT, SPECIAL, INCIDENTAL, CONSEQUENTIAL, OR MULTIPLE DAMAGES ARISING OUT OF THE USE OF THE PRODUCT OR DAMAGE TO THE CONNECTED EQUIPMENT, REGARDLESS OF THE LEGAL THEORY ON WHICH SUCH CLAIM IS BASED, EVEN IF ADVISED OF THE POSSIBILITY OF SUCH DAMAGE. SUCH DAMAGES INCLUDE, BUT ARE NOT LIMITED TO, LOSS OF PROFITS, LOSS OF SAVINGS OR REVENUE, LOSS OF USE OF THE PRODUCT OR THE CONNECTED EQUIPMENT OR ANY ASSOCIATED EQUIPMENT, LOSS OF SOFTWARE, COST OF CAPITAL, COST OF ANY SUBSTITUTE EQUIPMENT, FACILITIES OR SERVICES, DOWNTIME, THE CLAIMS OF THIRD PARTIES, INCLUDING CUSTOMERS, AND INJURY TO PROPERTY.

Submitting a Load Protection Policy Claim:

1. Any claim under the Load Protection Policy must be made within 10 days of the date of alleged damage to the Connected Equipment.
2. Call the XPC technical support department at 1-800- 582-4524 and obtain a Load Protection Policy Returned Material Authorization (RMA) number. Have information on all applicable insurance or other resources of recovery/payment that is available to the Purchaser and the name of the power utility supplier for the location of the Connected Equipment. XPC will forward to the Purchaser a Load Protection Policy claims form, which

must be completed and filed with XPC within 30 days.

- Mark the Load Protection Policy RMA number on the Product the Purchaser is returning.
- Pack the Product in its original packaging or similar packing materials if the original packaging has been discarded. Enclose the completed Load Protection Policy claim form and a copy of the Purchaser's original sales receipt for the Product in the box.
- Mark the RMA number clearly on the outside of the box.
- Ship the Product (one-way shipping charges paid by the Purchaser) to:

XPC Corporation
230 Yuma Street
Denver, CO 80223
Attn: LPP RMA#

3. XPC will evaluate the Product to determine its level of functionality, and will examine the Product for evidence of damage from a Power Disturbance.
 - If XPCs' evaluation provides no evidence of damage from a Power Disturbance, XPC will send to the Purchaser (i) a report summarizing the tests performed and (ii) a rejection of claim notice.
 - If the Product shows evidence of damage from a Power Disturbance, XPC will request that all Connected Equipment for which a Load Protection Policy claim has been submitted, be sent for evaluation to either XPC or an authorized service center. If it is determined that the Connected Equipment has been damaged by a Power Disturbance, XPC will, in its sole discretion, issue payment to the Purchaser for either the cost of repair of the Connected Equipment or the Fair Market Value of the damaged Connected Equipment, up to the dollar limits stated above. XPC reserves the right to require the Purchaser to transfer title and deliver the Connected Equipment to XPC if it chooses to reimburse the Purchaser for the fair market value of the Connected Equipment. XPCs' maximum liability shall be reduced to reflect all such other payments or sources of recovery, whether applied for or not.
4. If XPC issues payment to the Purchaser to have the Connected Equipment repaired, the repair must be performed at a service center that is authorized by the manufacturer of the Connected Equipment. XPC reserves the right to contact the authorized service center directly to discuss repair costs and damage to the Connected Equipment to determine if it was caused by a Power Disturbance and the right to request that the service center forward the Connected Equipment or components of the Connected Equipment to XPC for inspection
5. Unless modified in writing signed by an officer of XPC and the Purchaser, the terms of this policy are the complete and exclusive agreement between the parties, superseding all prior agreements, oral or written, and all other communications between the parties relating to the subject matter of this agreement. No employee of XPC or any other party is authorized to make any representations beyond those made in this agreement concerning the Load Protection Policy.

XPC Corporation
230 Yuma Street
Denver, CO 80223
1.800.582.4524