

	PROJECT M90S-6S			
	TITLE M90S-6S Outline Drawing			
APPROVED	SIZE	CODE	DWG NO	REV
CHECKED	A		M90S-6S-OTL-208/120-240/120-1-PH	0
DRAWN	6/16/2021	SCALE 1:16	WEIGHT	SHEET 1/4

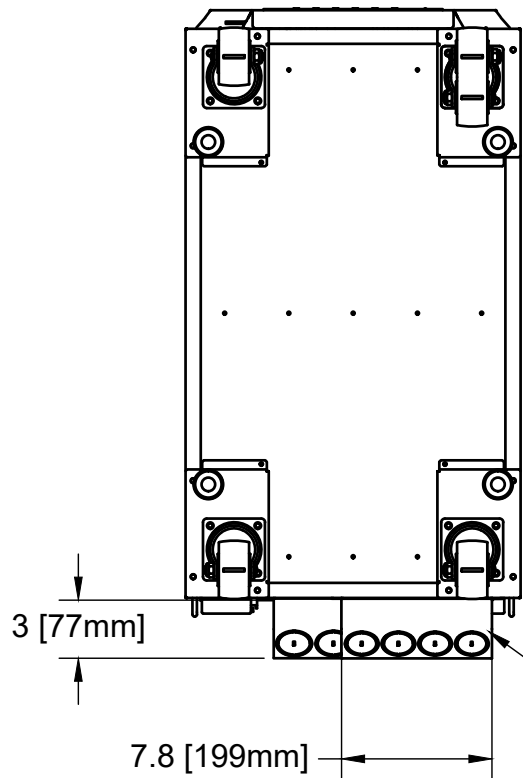

DC Landing Cover

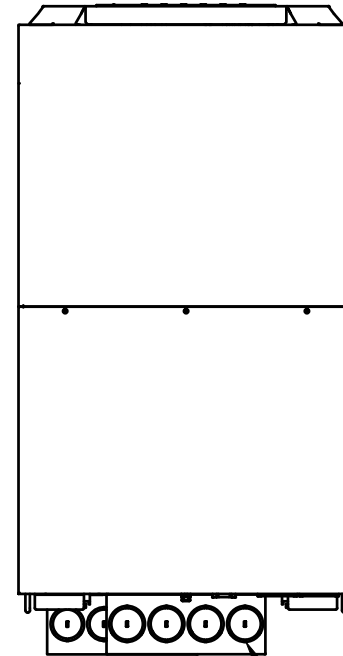

AC I/O Landing Cover

	PROJECT			
	M90S-6S			
	TITLE			
	M90S-6S Outline Drawing			
APPROVED	SIZE	CODE	DWG NO	REV
CHECKED	A		M90S-6S-OTL-208/120-240/120-1PH	0
DRAWN	6/16/2021	SCALE 1:10	WEIGHT	SHEET 2/4

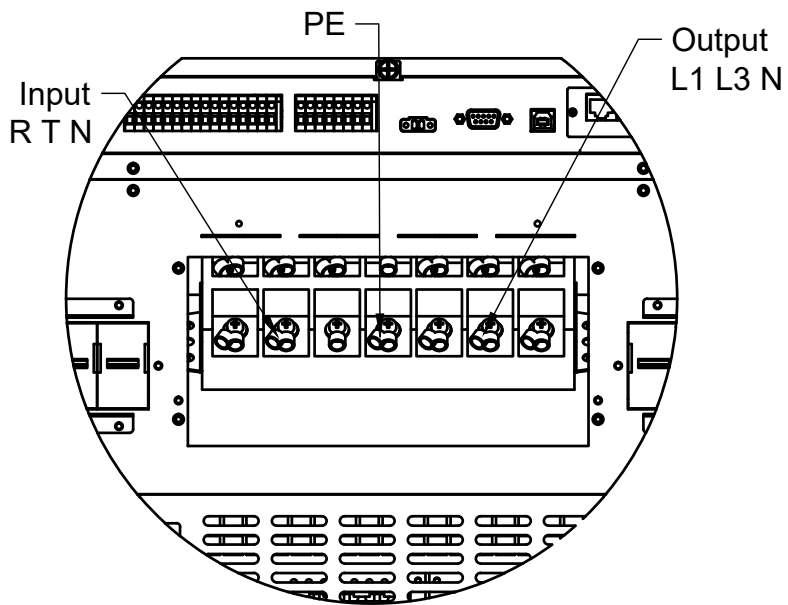
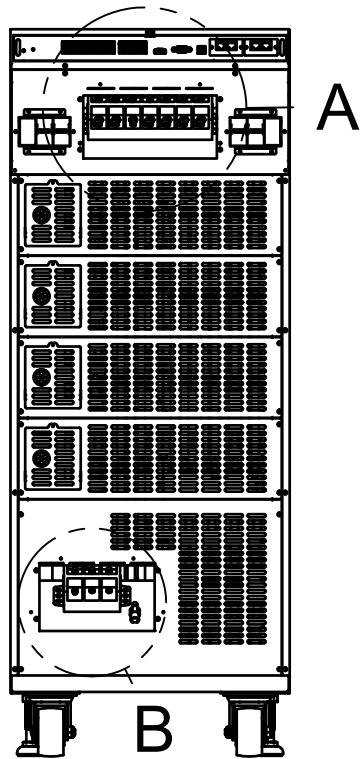

Callout A

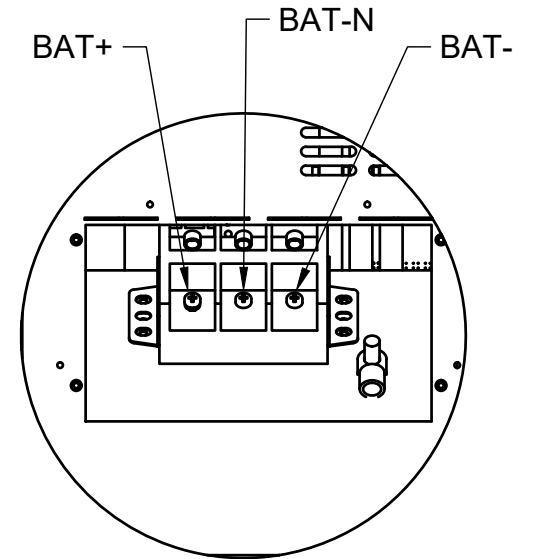

Callout B

	PROJECT			
	M90S-6S			
	TITLE			
	M90S-6S Outline Drawing			
APPROVED	SIZE	CODE	DWG NO	REV
CHECKED	A		M90S-6S-OTL-208/120-240/120-1PH	0
DRAWN	6/16/2021	SCALE 1:20	WEIGHT	SHEET 3/4

M90S Controller Module

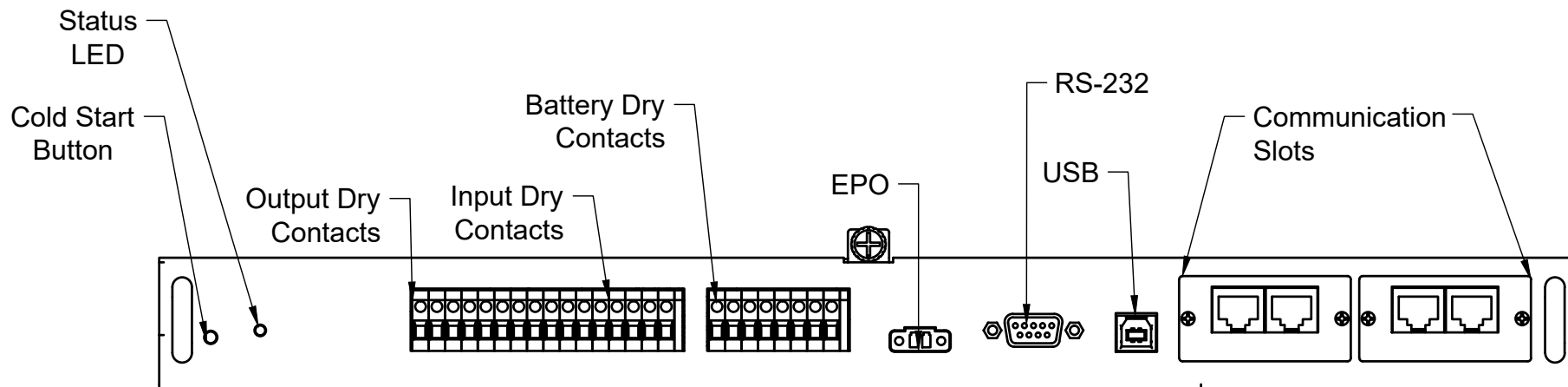

	PROJECT			REV
	M90S-6S			
TITLE				
M90S-6S Outline Drawing				
APPROVED	SIZE	CODE	DWG NO	REV
CHECKED	A		M90S-6S-OTL-208/120-240-120-1PH	0
DRAWN	6/16/2021	SCALE 1:10	WEIGHT	SHEET 4/4